

Data Sheet



Article number: 071071410250035

Description: Cardan drive shaft 0.107.141.001
S=250 X=35 Bore with keyway

Measures

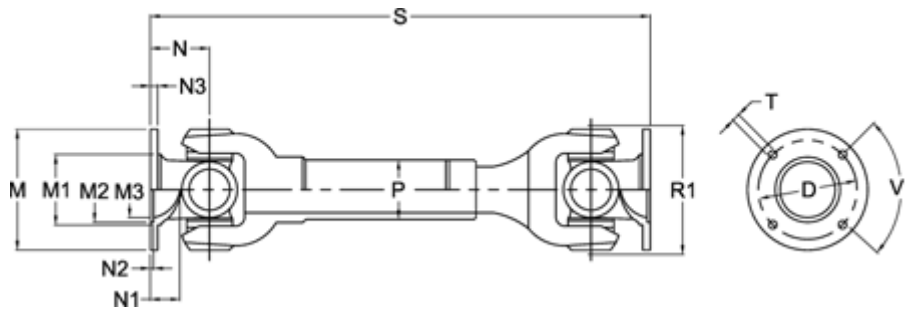

D	= 74,5 +-0,1	N1	= 18	T	= 8 B12
Extension X	= 35	N2	= 2,5 +0,3	V1 degrees	= 90
Flange diameter M	= 90	N3	= 6		
M1	= 56	Number og Flangeholes	= 4		
M2	= 47	P	= 40x2		
M3	= 38	R1	= 70		
Max. Bending Angle degrees	= 18	S min	= 250		
N	= 36	Spline dim. DIN 5480	= 28x1,5x17		